

Solar Pro

Omni Adjustable Skidsteer

Mounted Pile Driver Part Number 360001



Pneumatic • Hydraulic • Gasoline
Professional Grade Tools



Rhino Construction Equipment Attachments are professional-grade accessories, designed, built, and supported in the USA, to provide shorter lead-times and unmatched product support. Designed to expedite the installation of solar-panel supports (piles) utilized in ground-mounted solar projects, the Solar Pro's omni adjustable, powerful 800 ft. lb. (1,085 joule) hydraulic hammer safely increases jobsite productivity and profits.

Features and Benefits

Pile Driver Attachment is Omni Adjustable to ensure precise, prompt, and plumb, pile installations regardless of the job site terrain.

- Mast tilts 2° right, 90° left, and 10° front and back.
- Attachment adjusts 10" front-to-back, and 24" left to right.
- Accommodates solar panel supports (piles) up to 15' (457.2 cm) tall.

Utilize existing company owned (or rental) hydraulic operated skid steer.

- No need for an expensive self-propelled pile driver to complete projects on-time and on-budget.
- Universal Skid Steer mounting plate for quick attachment to most units. Rhino provided, custom mounting plate available on request.

State-of-the-art, Furukawa Fx 55 Hydraulic Hammer with 2-year warranty.

- Designed for efficient driving, dependability, and long life.
- Powerful 800 ft. lbs. (1,085 joules) of Impact energy per stroke (approx 1,000 blows/min.)
- New and improved piston (increased diameter and longer stroke) increases speed - Providing greater impact energy.
- Mono-block design - Reduced maintenance with only two moving parts.



Quality US materials and workmanship for dependability, low maintenance, and a long operating life.

- Parts and service available throughout the USA.
- Readily available SAE fittings and hardware - Overnight shipment available on most parts.
- Hydraulic components are inventoried, or repairable by most local hydraulic repair shops.





Optimal Positioning

The Solar Pro is off-set (right-side) so skid steer operator can easily maintain straight lines.

Reliable Operation

Designed for dependability, low maintenance, and a long life:

- Minimal grease zerks
- Occasional adjustment
- Designed, built and supported in the USA

Improved Mobility

Pile Driver Attachment retracts, and folds, for ease of transportation to and from the job site.



Scan QR for Videos



Adjust mast front-to-back: To accommodate for uneven terrain, mast tilts (front-to-back) 10° in each direction.

Adjust mast left or right: To accommodate for uneven terrain, mast tilts 2° right. The mast tilts 90° left for adjustment and transport.

Adjust attachment front-to-back: Attachment provides precise positioning front-to-back with 10" (25.4 cm) of adjustment.

Adjust attachment side-to-side: Attachment provides precise positioning side-to-side with 24" (61 cm) of adjustment.

"We've been using the Rhino Solar Pro for about 18 months, and we've had great luck with it. Rhino Tool has been very helpful in solving any issues. The machine is high quality and has performed well in nearly every situation. I like that we can use our skid loader to drive the piles as well as carry materials around the job site."

Jason Nisly, Installer at King Solar



Two quick-read, numbered, leveling indicators to plumb pilings.



Accommodates solar panel supports (piles) up to 15' (457.2 cm) tall



Easily transport company owned, or rental, hydraulic operated equipment (skid steer or loader) and Solar Pro Attachment.

Solar Pro Specifications	
Unit Weight	3,000 lbs. (1,361 kg)
Pile Driving Impact Energy	800 ft. lbs. (1,085 joules) Per Stroke
Blows Per Minute	Approximately 500 to 1,000
Omni Directional Adjustment for positioning the Pile and to Accommodate for Uneven Terrain	Mast Tilt 2 Degrees Right & 90 Degrees Left
	Mast Tilts 10 Degrees Forwards and Backwards
	10" (25.4cm) Front to Back Adjustment
	24" (61cm) Left to Right Adjustment
Unit Size Folded for Transportation	6' 2" H x 3' 10" W x 11' 8" L (1.88 x 1.17 x 140m)
Maximum Pile Height	15' (4.6m) Tall
* Standard Anvil - Max Footprint	8" x 7.25" (20.32 x 18.4cm)
* Optional Large Anvil - Max Footprint	10" x 7.25" (25.4 x 18.4cm)

*Custom sizes and shapes available.





Skid Steer Requirements	
Skid steer Minimum Operating Weight	> 10,000 lbs. (4,536 kg)
Skid steer Minimum Rated Operating Capacity	> 3,000 lbs. (1,360 kg)
Hydraulic Requirements	3-Lines: Pressure - Return - Case Drain
Hydraulic Operating Pressure Range	1740 - 2320 psi (120 - 160 bar)
Hydraulic Oil Flow Range	10.5 - 22.5 gpm (40 - 85 lpm)



Omni Directional Adjustment for precise positioning and leveling of the pile and to accommodate for Uneven Terrain

Versatility from one unit - Multiple Adapters to provide efficient driving of piles/post/ beam up to a maximum footprint of 10" x 7.25" (25.4 x 18.4cm), and maximum height of 15' (457.2 cm) tall.

Don't see your post type? Contact us about custom adapter fabrication.

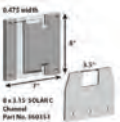
Adapter / Guide	Part No.	Pile / Post / Beam
	360350	Unirac 6" x 4"
	360351	7 x 4 Sinclair
	360365	9 x 4 Sinclair
	360352	S3-5.7 I-Beam
	360353	8 x 3.15 C Channel

Adapter / Guide	Part No.	Pile / Post / Beam
	360355	6" x 6" Plate for I-Beam Drives: W6" x 9 ft/lbs W6" x 15 ft/lbs
	360360	6" O.D. Round Pipe
	360369	Extended Drive Cap
	360374	Metal Pallet



Removable adapter plate, shown above. Custom sizes and shapes available.



Pile Lift Kit features a magnetic lift assist that attaches to the pile or post. With a rated lift strength of 1378 lbs and a max pull-off strength of 550 lbs, this accessory aids the operator in manipulating the pile/post from the ground into a vertical position. This accessory can easily be removed when not in use or while transporting. Part No.360270

Solar Pro Complete with 10" Anvil		
CEA / Anvil / Adapter / Guide	Part No.	Pile/Post Type
 <p>Your choice of Solar Pro Adapter 10" Anvil will fit all other Solar Pro Adapters</p>	360003	SINCLAIR 9 x 4

10" Anvil Kit		
Anvil / Adapter / Guide	Part No.	Pile/Post Type
	360277	SINCLAIR 9 x 4



Pile Puller Kit features a 1 ton vertical lift plate clamp and safety shackle attached to the steel pull plate on the front of the mast and hammer. A vertical pull capacity of 2000 lbs (1 ton) removes most pile/posts from the ground. This accessory can easily be removed when not in use or while transporting. Part No. 360267

Visit rhinotool.com for more details on Rhino Construction Equipment Accessories

A Tradition of Quality and Service Since 1975



RHINO TOOL COMPANY
1134 WEST SOUTH STREET • KEWANEE, IL 61443

www.rhinotool.com
866-707-1808

