



# Fence Pro™

## GAS/PETROL POST DRIVER OWNERS MANUAL



MODEL: 301001



# TAKE SAFETY SERIOUSLY

This book contains important safety information.  
Please read it carefully.



This owner's manual is considered a permanent part of the post driver and should remain with the post driver if resold, rented or loaned.

Your safety, and the safety of others, is very important. The proper and safe use of your Rhino® post driver is an important responsibility and should be taken seriously.

Keep this owner's manual available, so you can refer to it at any time. This owner's manual is considered a permanent part of the post driver and should remain with the post driver if resold.

The information and specifications included in this publication were in effect at the time of approval for printing. Rhino Tool Company, Inc. reserves the right, however, to discontinue or change specifications or design at any time without notice and without incurring any obligation whatever. No part of this publication may be reproduced without written permission from:

Rhino Tool Company

To help you make informed decisions about safety, you will find important safety information in a variety of forms, including:

- Safety Labels on the post driver
- Safety Messages Preceded by a safety alert symbol and one of three signal words, DANGER, WARNING, or CAUTION. These signal words mean:



Immediate hazards that will result in severe personal injury or death.



Hazards or unsafe practices that could result in personal injury.



Hazards or unsafe practices that could result in injury, product or property damage.

- Safety Headings such as IMPORTANT SAFETY INFORMATION.
- Safety Section such as POST DRIVER SAFETY.
- Instructions how to use this post driver correctly and safely.

# CONTENTS

<b>Safety Symbol Description</b> .....	i
<b>Table of Contents</b> .....	1
<b>Introduction</b> .....	2
<b>Post Driver Safety</b> .....	3
<b>Fence Pro™ Operating Instructions</b> .....	6
Starting the Engine .....	6
Hot Restart .....	8
Installing a Chuck Adapter.....	9
Fence Pro™ Maintenance .....	9
<b>Fence Pro™ Service Instructions</b> .....	10
Servicing Crankshaft and Piston .....	11
Service of the Hammer and Anvil .....	12
<b>Fence Pro™ Parts List</b> .....	16
<b>Limited Warranty and Registration</b> .....	20
<b>Troubleshooting</b> .....	ii

## INTRODUCTION

Congratulations on your selection of the Rhino® Fence Pro™ post driver. We are certain that you will be pleased with your purchase. This post driver was built with the Honda GX35 engine. Honda supplies its own owner's manual that covers all the operator and service issues associated with the Honda engine. Please read this manual as closely as you do the Rhino manual. The success that you experience with this tool is dependent upon your knowledge and understanding of how to properly operate and care for the Honda engine installed on your new post driver.

As you read this manual, you will find information preceded by a NOTICE symbol. That information is intended to help you avoid damage to your post driver, other property, or the environment.

We suggest you read the warranty information fully and understand its coverage and your responsibilities of ownership. Fill out the warranty registration card or online registration to receive Rhino® Lifetime Impact Warranty. (See Page 20)

Please read and understand the Honda warranty policy. The Honda warranty is separate from the Rhino® warranty and is subject to its own coverage conditions and responsibility requirements. The warranty is a separate document and should have been included with the Honda owner's manual.

When your Rhino® Post Driver needs scheduled maintenance, the technical service staff here at Rhino Tool Company is standing by to assist you if you require assistance. Our fully trained staff can

ensure that you receive the correct service kit or direct you to the nearest Rhino Servicing Dealer.

If it is the engine that requires scheduled maintenance, keep in mind that your Honda service dealer is fully equipped and specially trained in servicing the Honda engine. Your Honda servicing dealer is dedicated to your satisfaction, and will be pleased to answer your questions and concerns.

Kindest Regards

The Rhino Tool Company Team



**Driven To  
Perfection!**

## POST DRIVER SAFETY

## IMPORTANT SAFETY INFORMATION

The Rhino® Fence Pro™ gas powered driver is designed to drive fence posts, ground rod, form pins, and other like items into the ground.

**⚠ CAUTION** Uses, other than those intended, can result in injury to the operator as well as those around the operator. Damage to the driver and to the surrounding area may result as well. This post driver is intended for use by professional installers. Never allow children to operate this tool.

Most accidents can be prevented if you follow all instructions in this manual and on the post driver. The most common hazards are discussed below, along with the best method to protect yourself and others.

**⚠ WARNING UNDERGROUND UTILITIES:** Driving a post into an underground utility can be **EXTREMELY DANGEROUS**, exposing the operator and those around to potentially life threatening danger. Damage to surrounding property can also occur as a result of a post being driven into an under-

ground utility. Be absolutely certain that you are aware of all underground utilities in the area in which you intend to drive posts. Ensure that a certified locating service has identified all underground utilities prior to beginning your project. Failure to do so can be catastrophic. Underground utilities include but are not limited to: Electric, Gas, Telephone, Water, Sewer, TV Cable, Lawn Sprinklers, etc.

**⚠ WARNING GASOLINE:** Gasoline is **HIGHLY FLAMMABLE** and **EXPLOSIVE**. You can be burned or seriously injured when handling fuel.

**⚠ WARNING EXHAUST:** The exhaust from the engine contains poisonous carbon monoxide gas that can build up to dangerous levels in closed areas. Breathing carbon monoxide can cause unconsciousness or death. Never run the engine in a closed or even partly closed area where people may be present.

**⚠ WARNING** The engine exhaust

from this product contains chemicals known to the State of California to cause cancer, birth defects or other reproductive harm.

**⚠ WARNING ENGINE MAINTENANCE:** Improperly maintaining the engine on this power tool, or failure to correct a problem before operation, can cause a malfunction in which you can be seriously hurt or killed.

In accordance with the engine owner's manual, always perform a pre-operation inspection of the engine before each use and correct any problem.

**⚠ WARNING DRIVER MAINTENANCE:** Improperly maintaining the driving mechanism on this power tool, or failure to correct a problem before operation, can cause a malfunction in which you can be seriously hurt or killed. In accordance with this manual, always perform a pre-operation inspection of the driving mechanism before each use and correct any problem.



### WARNING

**Do not** lend or rent your post driver without the instruction manuals. Be sure that anyone using it understands the information contained in these manuals.



### WARNING

**Do not** use this post driver for any purpose other than driving posts into the ground. Misuse may result in personal injury or property damage, including damage to the machine.



### WARNING

Minors should never be allowed to use this power tool. Bystanders, especially children, and animals should not be allowed in the area where it is in use. Any bystanders or crew without proper safety equipment should keep a distance of 20 feet (6.00m) from the driver when it is in operation.



### WARNING

**NEVER** let your power tool run unattended. When it is not in use, shut it off and make sure that unauthorized persons do not use it.



### WARNING

**Do not operate** this post driver unless the operator is wearing safety glasses, safety shoes, hearing protection, gloves or any other safety equipment advised by, ANSI, NIOSH, OSHA, or any other safety regulatory agency, or the employer or the owner of this post driver.

**Hearing protection is required** as the post driver emits noise at 100 dB level. Bystanders should, at a minimum, wear safety glasses and hearing protection while in the presence of this power tool during operation. If not wearing protective gear, bystanders should keep a distance of 20 feet (6 m) from the post driver while in operation.



### WARNING

Prolonged use of a power tool (or other machines) exposing the operator to vibrations may produce white finger disease (Raynaud's phenomenon) or carpal tunnel syndrome. These conditions reduce the hand's ability to feel and regulate temperature, produce numbness and burning

sensations and may cause nerve and circulation damage and tissue necrosis.

Not all factors contributing to white finger disease are known, but cold weather, smoking and diseases or physical conditions that affect blood vessels and blood transport, as well as high vibration levels and long periods of exposure to vibration are mentioned as factors in the development of white finger disease. In order to reduce the risk of white finger disease and carpal tunnel syndrome, please note the following:

- The Fence Pro™ has been designed with Rhino® CIS™ anti-vibration handles to reduce the transmission of vibrations created by the machine to the operator's hands. An anti-vibration system is recommended for those persons using power tools on a regular or sustained basis.
- The handle opposite the throttle handle has been fitted with an EPDM foam grip further dampening vibrations.
- Wear gloves and keep your hands warm.

- Ensure that the EPDM foam and the spring dampening system are in good working condition.
- Ensure the post driver has no loose components. Loose components lead to high vibration levels.
- Maintain a firm grip at all times, but do not squeeze the handles with constant, excessive pressure. Take frequent breaks.

All of the above mentioned precautions do not guarantee that you will not sustain white finger disease or carpal tunnel syndrome. Therefore, continual and regular users should closely monitor the condition of their hands and fingers. If any of the above symptoms appear, seek medical advice immediately.



## WARNING

**DO NOT** modify this power tool in any way.



## CAUTION

**DO NOT** put anything other than a post into the chuck on the driver.



## CAUTION

**DO NOT** operate

your post driver unless it is on a post to be driven. Operation of the driver without it driving on a post could damage the power tool.



## CAUTION

### SURROUNDINGS:

This power tool emits noise at 100 Db or more, which may be disturbing to animals and livestock. Ensure prior to operation, that any livestock are cleared from the operational area to prevent a situation in which startled livestock become a safety hazard.

### WARNING LABELS

If your post driver's warning label is marred or destroyed, replace it immediately. Simply contact your Rhino Tool Company representative to replace your warning label at no expense to you.

### End of Life Cycle

When your Rhino® gas powered driver is coming to the end of its life cycle, destruction of the unit should be conducted according to international and local environmental regulations.

The gas powered post driver contains:

- Fuel
- Oil
- Rhino® Pro Series Lubricant
- Electric components
- Plastic-steel and aluminum components.

### Specifications imperial (metric)

Overall Dimensions	13 x 14 x 21.5 in. (330 x 355 x 546 mm)
Weight	36.5 lb (15.5 kg)
Engine Configuration	4-stroke, 35.8 cc
Performance	1720 bpm
Fuel	Unleaded Gas, US 86 Octane (>Euro 91)
Fuel Capacity	0.67 US qt. (0.63 ltr)
Engine Oil	SAE 10W-30
Lubricant	Rhino® Pro Series Lubricant
Noise	≤ 100 Db
Vibration	TBC

# OPERATING INSTRUCTIONS

Your Rhino® Fence Pro™ Gas Powered Post Driver is an efficient and effective power tool designed and developed to tackle a difficult and time consuming task, driving posts.

It is very important to understand that your post driver is a powerful machine; it has to do the very difficult job it is designed to perform. With proper care and mainte-

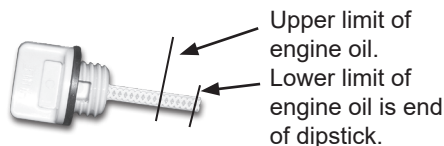

Fig. 1  
6

nance, your post driver will give you many years of trouble free service.

You must read and understand your post driver operating instructions before using the post driver. It is also very important that you make sure all operators are trained to operate your post driver safely. If you or any operator doesn't understand any of the instructions in this manual, call Rhino Tool Company at 866-707-1808 or 309-853-5555 and we will answer any questions you may have or contact your nearest Dealer or Distributor.

## **⚠ WARNING** AVOID SERIOUS INJURY OR DEATH READ THIS MANUAL BEFORE USING YOUR POST DRIVER

Visually inspect your Fence Pro™ Post Driver before use. The interior of the chuck tube should be checked for obstructions, damage or wear to the chuck tube and anvil inside. The outer surfaces of the driver should also be inspected for any defects. Do not use the Fence Pro™ if there is any damage or wear until the damage or

wear is corrected and repaired.

Check all fluid levels, i.e. engine oil and fuel and fill as needed as per manufacturer's specifications. (Fig. 1)

**NOTE** Proper oil level is essential to the proper operation of the post driver. Overfilling of the oil will result in loss of power and may cause permanent damage to the engine.

**⚠ WARNING** USE ALL RECOMMENDED SAFETY EQUIPMENT.

Rest the driver on a solid surface, i.e. tailgate, bench, or debris free solid ground and posture your body in a safe position. DO NOT start the driver anywhere but an open, well-ventilated area. It is recommended that the Fence Pro™ only be used outdoors and never inside an enclosed building.

### Starting the Engine:

To start a COLD engine, move the choke lever to the CLOSED position (Fig. 3).



# OPERATING INSTRUCTIONS

Lock the throttle by depressing the trigger and while the trigger is depressed, push in the button next to the thumb switch. Hold the button in and release the trigger. The throttle is now in the high idle position (Fig 2).

To start a WARM engine, leave the choke lever in the OPEN position and do not lock the throttle into the high idle position. Press the priming bulb repeatedly until fuel can be seen in the clear-plastic fuel return tube (Fig 4).

Slide thumb switch on throttle handle down or into the ON position.

Grasp the starter grip lightly until you

Thumb Switch

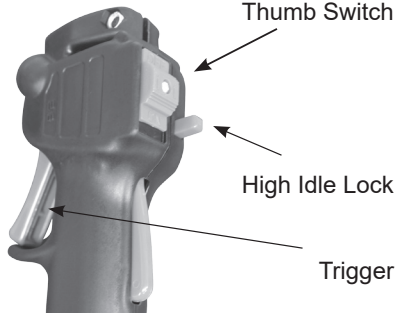

Fig. 2

feel resistance, then pull briskly in the direction of the arrow as shown in Fig. 5. Return the starter grip gently.

**CAUTION** Do not extend the starter rope to its full length as it can cause damage the recoil mechanism.

**CAUTION** An operator should never wrap the starter rope around their hand. This will cause serious injury.

**NOTE** Do not allow the starter grip to snap back against the engine. Return it gently to prevent damage to the starter.

If the choke lever was moved to the

Choke Closed

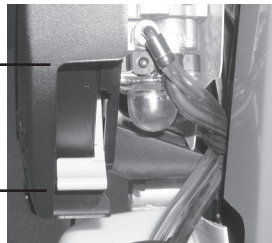
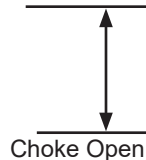

Fig. 3

CLOSED position to start the engine, gradually move it to the open position as the engine warms up. As the engine warms up also release the high idle lock by slightly depressing the trigger and then immediately releasing it. Use caution as to not engage the clutch. Dry-Firing (running the post driver without striking a post) will shorten the life of the post driver and could cause damage.

Priming Bulb

Fuel Return Line (clear plastic tube)

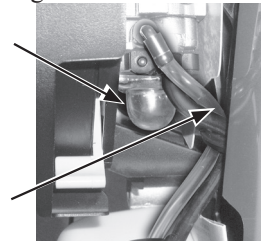

Fig. 4

Starter Grip

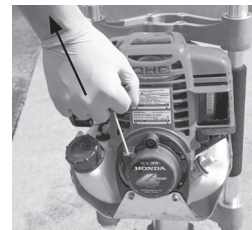

Fig. 5

# OPERATING INSTRUCTIONS

## Hot Restart

If the engine is operated at higher ambient temperatures, then turned off and allowed to sit for a short time, it may not restart on the first pull. If necessary, use the following procedure: Failure to follow instructions can result in personal injury.



**WARNING**

**IMPORTANT  
SAFETY  
PRECAUTION**

Turn the engine switch to the OFF position before performing the following procedure. This will prevent the engine from starting and running at maximum speed when the throttle is in the MAX. speed position. If the engine starts with the throttle in the MAX. speed position, the post driver will operate at maximum power. This may result in personal injury and damage to the post driver.

1. Turn the engine switch on the post driver to the OFF position.
2. Move the choke lever to the OPEN position.

3. Hold the throttle in the MAX speed position.

4. Pull the starter grip 3 to 5 times.

Follow the STARTING THE ENGINE procedure on the previous page and start the engine with the choke lever in the OPEN position.

## Driving A Post:

Holding the post driver with your left hand on the foam grip and your right hand on the throttle will position the driver to direct the engine exhaust away from the operator (**Fig 6**) (See Exhaust Warning). Insert a post into the Fence Pro™ making sure the end of the post to be driven is in the correct location on the ground. (**Fig. 7**)

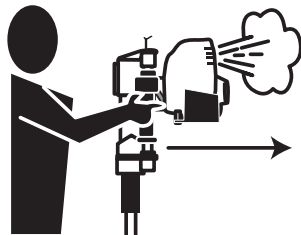

Fig. 6

Position the driver aligned and centered to the post. If not aligned properly, damage could be caused to the driver or the post.

Apply steady downward pressure to the handles and apply enough throttle to engage the clutch and hammer.

Once you are confident that the post is driving straight, apply full throttle to the driver until the post is driven to the desired depth.

Release the trigger dropping the engine RPM back to idle before removing from

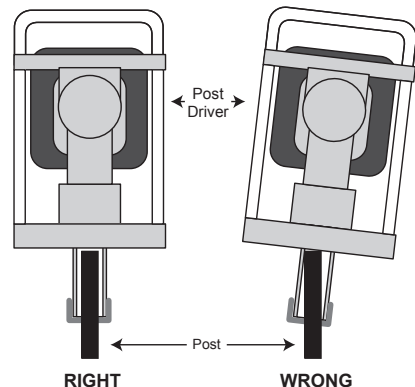

Fig. 7

# OPERATING INSTRUCTIONS

the post. When the engine has returned to idle, proceed to the next post repeating the previous method of driving a post.

## Installing a Chuck Adapter

**Chuck Size:** A chuck or chuck adapter that is too large for the post being driven may damage the driver and may batter the end of the post. Using the appropriate chuck adapter will align the post to optimum striking position. This prevents damage to the driver. See the chart below to specify the appropriate adapter for your application. Chucks and chuck adapters wear out and should be replaced as needed. Inspect your driver's chuck and chuck adapters frequently.

Type or Size of Post to be Driven	Chuck/Adapter Required
Fiberglass T-Post	1.75"(44.45mm) Adapter
T-Post	1.75"(44.45mm) Adapter
5/8"(15.87mm) to 3/4" (19 mm) Ground Rod	1"(25.4mm) Adapter
1" (25.4mm) to 1-5/8" (41.27) Post	1.75"(44.45mm) Adapter
1" (25.4mm) to 1-7/8" (47.62mm) Post	2" (50.8mm) Adapter
2"(50.8mm) to 2-3/8" (60.32 mm)Post	Master Chuck

The Rhino® Fence Pro™ equipped with the Rhino® Chuck-Lok™ Adapter System. It is comprised of a master chuck, the locking nut and two-piece adapters.

**⚠ WARNING ALWAYS HAVE THE LOCKING NUT IN PLACE WHEN DRIVING POSTS:**

The Chuck-Lok™ locking nut should always be tightened onto the master chuck to protect the chuck threads, even when not using an adapter. Failure to do so exposes the chuck to possible damage.

The two-piece adapter design is a solution for the occasional flared post. Should a post flare and lodge inside the chuck

when using the adapter, in most cases the operator can loosen the locking nut letting it slide down the post, then lift the driver off the post. The operator can quickly re-insert the adapter, secure them with the locking nut and resume driving posts. See Fig. 8 for steps for installing Chuck-Lok™ adapters.

## Maintenance of the Fence Pro™

**⚠ WARNING NEVER REFUEL WITH THE ENGINE HOT OR RUNNING**

Never refuel your Fence Pro™ with the engine hot or running as there is a possibility the flammable fumes from the gasoline

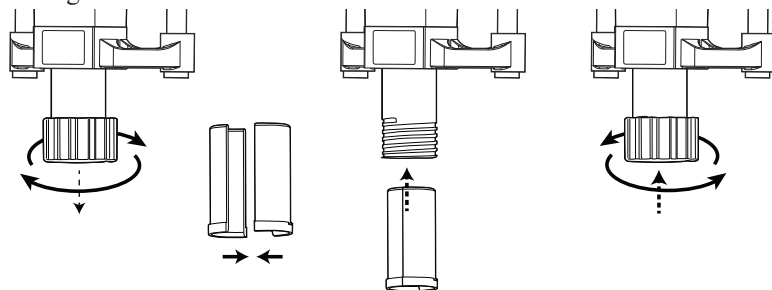

Fig. 8 - Hand tighten ONLY. No Tools.

# SERVICE INSTRUCTIONS

can ignite, causing severe injury and/or damage to you, your post driver and the surrounding area. Follow engine manufacturer's instructions for the refueling of the engine.



## **WARNING DO NOT OPEN CRANKCASE COVER WHILE ENGINE IS RUNNING.**

With each use check the engine oil level, air filter, and all fasteners. If necessary, add oil, clean or replace the air filter and tighten any loose nuts, bolts, or any other fastener. (See page 6 for engine oil level)

Change engine oil as per engine manufacturer's specifications. Dispose of used oil in accordance with any local, state, or federal regulations. To help insure years of operation, wipe down the Fence Pro™ with a clean cloth after each days use.

Following the service requirements for the Fence Pro™ will insure years of trouble free operation. Always refer to the Honda GX35 manual for maintenance and service on the engine. The following instructions

are for the Rhino® Fence Pro™ specifically with general instructions for the Honda GX35. Before any service is preformed, remove the spark plug wire from the spark plug and ground it to the engine body to prevent any accidental start-up of the engine.

### **Each Use**

1. Check engine oil level. Add SAE 10W-30 oil, if necessary.
2. Check engine air cleaner. If soiled, clean or replace.
3. Check crankshaft and piston lubrication. (See page 11 for instructions.)
4. Check all engine and post driver fasteners. Retighten to proper specifications if necessary. (See Bolt Torque Specifications on page 19)

### **First Month or 10 Hours Use of a New or Rebuilt Fence Pro™**

1. Change engine oil following the requirement for the Honda GX35. Dispose of used oil according to all local, state, and federal regulations.

2. Check crankshaft and piston lubrication. (See page 11 for instructions.)
3. Check all engine and post driver fasteners. Retighten to proper torque specifications if necessary. (See page 19)

### **Every 3 Months or 25 Hours of Use**

1. Change engine oil following the requirement for the Honda GX35. Dispose of used oil according to all local, state, and federal regulations.
2. Replace air cleaner elements. This should be performed more often if operated in dusty areas.
3. Check crankshaft and piston lubrication. (See page 11 for instructions.)
4. Check all engine and post driver fasteners. Retighten to proper torque specifications if necessary. (See page 19)

### **Every 6 Months or 50 Hours of Use**

1. Change engine oil following the requirement for the Honda GX35. Dispose of used oil according to all local, state, and federal regulations.

# SERVICE INSTRUCTIONS

2. Replace air cleaner elements. This should be performed more often if operated in dusty areas.
3. Check crankshaft and piston lubrication. (See page 11 for instructions.)
4. Check all engine and post driver fasteners. Retighten to proper torque specifications if necessary. (See page 19)

## Every 12 Months or 100 Hours of Use

1. Change engine oil following the requirement for the Honda GX35. Dispose of used oil according to all local, state, and federal regulations.
2. Replace air cleaner elements. This should be performed more often if operated in dusty areas.
3. Check crankshaft and piston lubrication. (See page 11 for instructions.)
4. Remove and service the hammer and anvil. (See page 12 for instructions.)
5. Check all engine and post driver fasteners. Retighten to proper torque specifications if necessary. (See page 19)

## Servicing Crankshaft and Piston Lubrication

The crankcase cover (p/n 300132) is designed for easy, “no tool” inspection and maintenance (**Fig. 9**). To remove the cover, grip it tightly with your hand and twist it left (counter-clockwise.) Use caution not to lose or damage the O-ring Seal (p/n 301617).



**CAUTION**

**DO NOT USE A HAMMER OR WRENCHES TO**

**LOOSEN THE COVER AS IT MAY CAUSE DAMAGE TO THE DRIVER.**



**Fig. 9 - Crankcase Cover**

Visually inspect the color and amount of Rhino® Pro Series Lubricant inside the crankcase. There should be a ring of Rhino® Pro Series Lubricant collected to the wall inside the crankcase. Should the depth of the ring from the wall inward measure 1/8" (3 mm) or less (**Fig. 10**) this indicates the Lubricant is low. The maximum level should not be more than 1/4" (6 mm). If the amount of Lubricant appears to be low, add a small amount of Rhino® Pro Series Lubricant. Use only Rhino® Pro Series Lubricant (p/n 300500.)

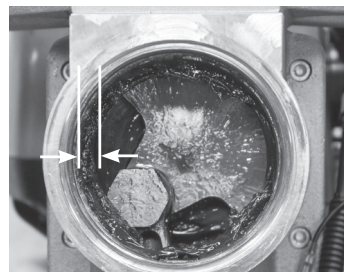

**Fig. 10 - If ridge of Rhino® Pro Series Lubricant measures 1/8" or less, add a small amount. At maximum level it should measure 1/4".**

# SERVICE INSTRUCTIONS



## CAUTION

**DO NOT OVER-FILL RHINO® PRO SERIES LUBRICANT AS IT CAN DAMAGE THE DRIVER AND THE HONDA ENGINE.**

If the Rhino® Pro Series Lubricant is discolored, very dark or black, the post driver will need further maintenance. This is detailed in the section titled “Service of the Hammer and Anvil.”

In the event of complete removal of old Lubricant and adding fresh Lubricant (**Fig. 11**) rotate the crankshaft with connect-

Rotate Crankshaft until crank pin is in 12:00 o'clock position.

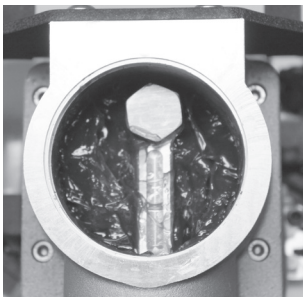

Fig. 11 - After completely cleaning out old Lubricant, add new Rhino® Pro Series Lubricant till level with the bottom edge of the crank pin head.

ing rod and crank pin until the crank pin is in the 12:00 o'clock position, then add Rhino® Pro Series Lubricant (p/n 300500). The level of Rhino® Pro Series Lubricant should be to the bottom of the crank pin head. When the required service has been performed in the crankcase, inspect the o-ring seal and replace it on the crankcase cover. Position the crankcase cover on the Fence Pro™ body carefully to start the threads and once in the thread groove, with your hand twist to the right (clockwise) until it is securely in contact with the post driver body.

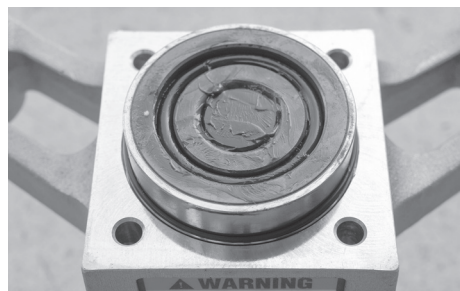

Fig. 12 - View of the Lower Driver Body Assembly when removed from the post driver.



## CAUTION

**HAND TIGHTEN ONLY. DO NOT OVERTIGHTEN.**

Do not use tools, such as a hammer or wrench, to tighten the crankcase cover as it will damage the driver.

## Service of the Hammer and Anvil

The tools required for servicing the hammer and anvil are, a 9/64" hex wrench, a 1/4" hex wrench, a 7/8" deep well socket with handle, a torque wrench that reads in inch/pounds (Nm), threadlocker primer and threadlocker.

Remove the four (4) bolts (p/n 300702-4) in the bottom of the lower driver body (p/n 301034). Use caution as the handle tubes (p/n 300232) have anti-vibration springs (p/n 610010-4) installed and they are under tension. When the lower driver body is removed, it should appear as shown in **Fig. 12**. The anvil o-ring retainer (p/n 301110) will sometimes be removed with the lower driver body or remain in place.

Remove the anvil o-ring cup (p/n 301090) and the anvil (p/n 301160). This can be

## SERVICE INSTRUCTIONS

accomplished by pushing a 1" dowel rod or hammer handle into the chuck tube from the opposite side. **When the parts are removed, note the order of assembly, position of large retainer radius,** and disassemble for inspection. Check the anvil for any wear. The anvil o-ring (p/n 301616) should be replaced at this time. Clean the anvil and carefully replace the anvil o-ring. **Fig 13** shows an anvil with the o-ring in place.

Remove the large retainer o-ring seals (p/n 301614-2) and the large retainer (p/n 301100) from the anvil o-ring cup. Inspect the large retainer. The large retainer o-ring seals should be replaced at this time. Replace the large retainer if there are any



**Fig. 13** - Anvil with O-ring in place.

signs of damage or excessive wear.

The anvil o-ring retainer can be removed from the end of the cylinder in the post driver body (p/n 301015) by hand. Use caution as it can become sharp with use of the driver. Remove the hammer (p/n 301080), piston and connecting rod (p/n 301075) by removing the crank pin (p/n 300050). Access to the crank pin is achieved by removing the crankcase cover, which is described in the section titled "Servicing Crankshaft and Piston Lubrication" shown in the previous pages of this manual. Remove the crank pin using the 7/8" deep well socket.



**CAUTION**

**THE CRANK PIN  
HAS LEFT-HAND  
THREADS.**

Use caution holding the connecting rod and crankshaft (p/n 300040). The connecting rod and crankshaft can be damaged. Use a small wood or plastic block to keep the crankshaft from rotating. When the crank pin is removed, the piston, connecting rod, hammer can be removed by

pushing the connecting rod down into the cylinder until it can be removed from the bottom of the post driver body. Note orientation of the hammer. The small end of the hammer is toward the anvil as shown in **Fig. 14**. Clean and inspect the hammer for damage or excessive wear. The hammer o-ring Seal should be replaced at this time.

Clean and inspect the piston and connecting rod. Insert the crank pin into the bearing on the connecting rod. If there is excessive play between the two, the connecting rod and piston assembly and possibly the crank pin should be replaced. Check the movement in the bearing in the piston side. If there is excessive play the connecting rod and piston assembly should be replaced. The piston o-ring seal

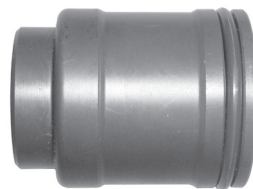

**Fig. 14** - Small end of Hammer is toward the anvil.

## SERVICE INSTRUCTIONS

(p/n 301610-2) should be replaced at this time. See (Fig. 15)

Clean and inspect the cylinder and crankcase for any damage or wear. Replace any damaged parts. Lubricate the cylinder, piston and connecting rod with Rhino Pro Series Lubricant (p/n 300500.)

### **IMPORTANT** RECOMMENDED THREADLOCKER

**PROCEDURE:** Clean any residue from the bolts and internal bolt threads with acetone or solvent. Apply threadlocker primer to the bolt holes and bolt threads and allow the primer to dry. Follow with an application of threadlocker to the bolt hole threads.

Follow threadlocker procedure for installing the crank pin. Insert the connecting rod, with the piston attached,

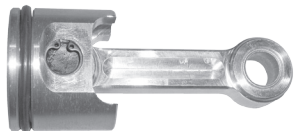

**Fig. 15** - Piston with Connecting Rod and O-ring Seal in place.

into the cylinder. Push the piston up the cylinder until the bearing in the connection rod aligns with the threaded hole for the crank pin. Insert the crank pin through the bearing and start the threads into the Crankshaft by hand. These are **LEFT-HAND THREADS**. Tighten the crank pin using the 7/8" deep well socket. Torque to 360 inch/pounds (40.6 Nm). Add Rhino® Pro Series Lubricant (p/n 300500) to the crankcase to the level shown in **Fig. 11**. (See **Caution: Do not overfill Rhino® Pro Series Lubricant (p/n 300500) on page 12**) If Lubricant has been completely removed, add 2.75 oz or 81.32 ml of Rhino® Pro Series Lubricant or until level with the bottom of the crankpin head.

Close the crankcase by placing the crankcase cover o-ring seal onto the crankcase cover. Place the crankcase cover onto the post driver body, start the thread, and twist to the right (clockwise) with your hand until it is secure against the post driver body. (See **Caution: Do Not Overtighten on page 12**) Lubricate the cylinder and hammer with Rhino® Pro Series Lubricant

(p/n 300500.) Insert the hammer into the cylinder, taking note of the small end to the anvil as shown in **Fig. 13**. Push the hammer into the cylinder making room to insert the anvil o-ring retainer. Apply Rhino® Pro Series Lubricant to the anvil o-ring retainer and place the small end into the cylinder. The Lubricant should hold it in place.

Lubricate with Rhino® Pro Series Lubricant and assemble the large retainer and the two (2) large retainer o-ring seals in the order shown in **Fig. 16** and assemble into the anvil o-ring cup ensuring the large radius on the large retainer is positioned toward the anvil.



**CAUTION** THE LARGE  
RADIUS OF THE  
LARGE RETAINER MUST BE POSI-  
TIONED DOWNWARD FACING THE  
ANVIL OR IT WILL CAUSE DAM-  
AGE TO THE DRIVER.

On previous GPD-40 models, Large Retainer does not have radius and can be installed on either side.

**NOTE**



## SERVICE INSTRUCTIONS

Clean and inspect the chuck tube and lower driver body assembly (p/n 301034) for any damage or excessive wear. Replace if necessary. Lubricate chuck tube with Rhino® Pro Series Lubricant. Lubricate the anvil with Rhino® Pro Series Lubricant. Insert the anvil with new anvil o-ring into chuck tube, making certain that the anvil is

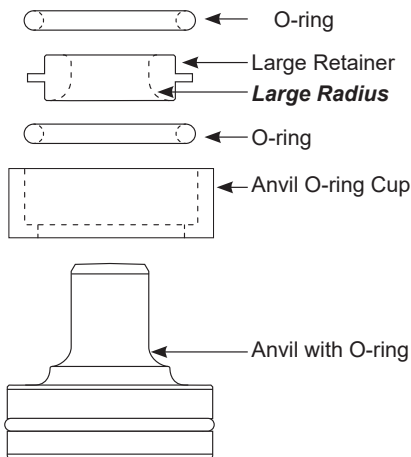

**Fig. 16** - Insert o-ring into anvil o-ring cup, then insert large retainer with large radius at bottom towards the anvil, then insert other o-ring.

seated into the chuck tube. Insert the anvil o-ring cup into the chuck tube. Replace the chuck tube o-ring (p/n 300608) and insert the chuck tube o-ring onto the chuck tube. It should look like **Fig. 17**.

Remove the handle tubes (p/n 300232) from the handle cups and remove and clean and lubricate with Rhino® Pro Series Lubricant all four (4) anti-vibration springs (p/n 60010-4.) Check all handle cups for wear. Clean and lubricate the upper and lower cups the handle tubes fit into with a small amount of Rhino® Pro Series Lubricant (p/n 300500). Insert the anti-vibration springs into the handle tubes. Assemble the handle tubes into the upper handle cups. Insert the chuck tube

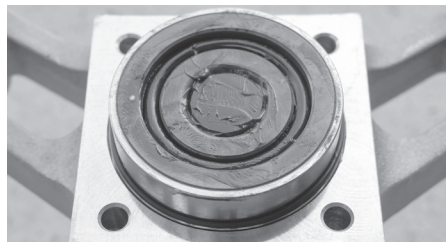

**Fig. 17** - Elements reassembled into chuck tube.

into the post driver body, taking care to insert the handle tubes into the handle cups on the lower driver body. When parts are inserted in the proper position, there will be resistance from the anti-vibration springs to seat the lower driver body on to the post driver body. This is normal.

**Follow the threadlocker procedure on page 14** to prepare the bolts. Insert and hand thread the four (4) lower body bolts through the lower driver body into the post driver body. Use a 1/4" hex wrench to tighten the bolts in a star pattern until the lower driver body is seated on the post driver body. Check for any misalignment or binding when joining the parts.

### **DO NOT USE EXCESSIVE FORCE.**

Using a torque wrench set to 132 lb/in (14.9 Nm) for stainless bolts or 251 lb/in (28.4 Nm) for black oxide bolts, tighten to the correct torque. Perform a visual check of the post driver. Reconnect the spark plug wire to the spark plug. Check that the engine has the proper amount of oil. Start the engine using the proper procedure and test the post driver.

# RHINO® FENCE PRO™ PARTS

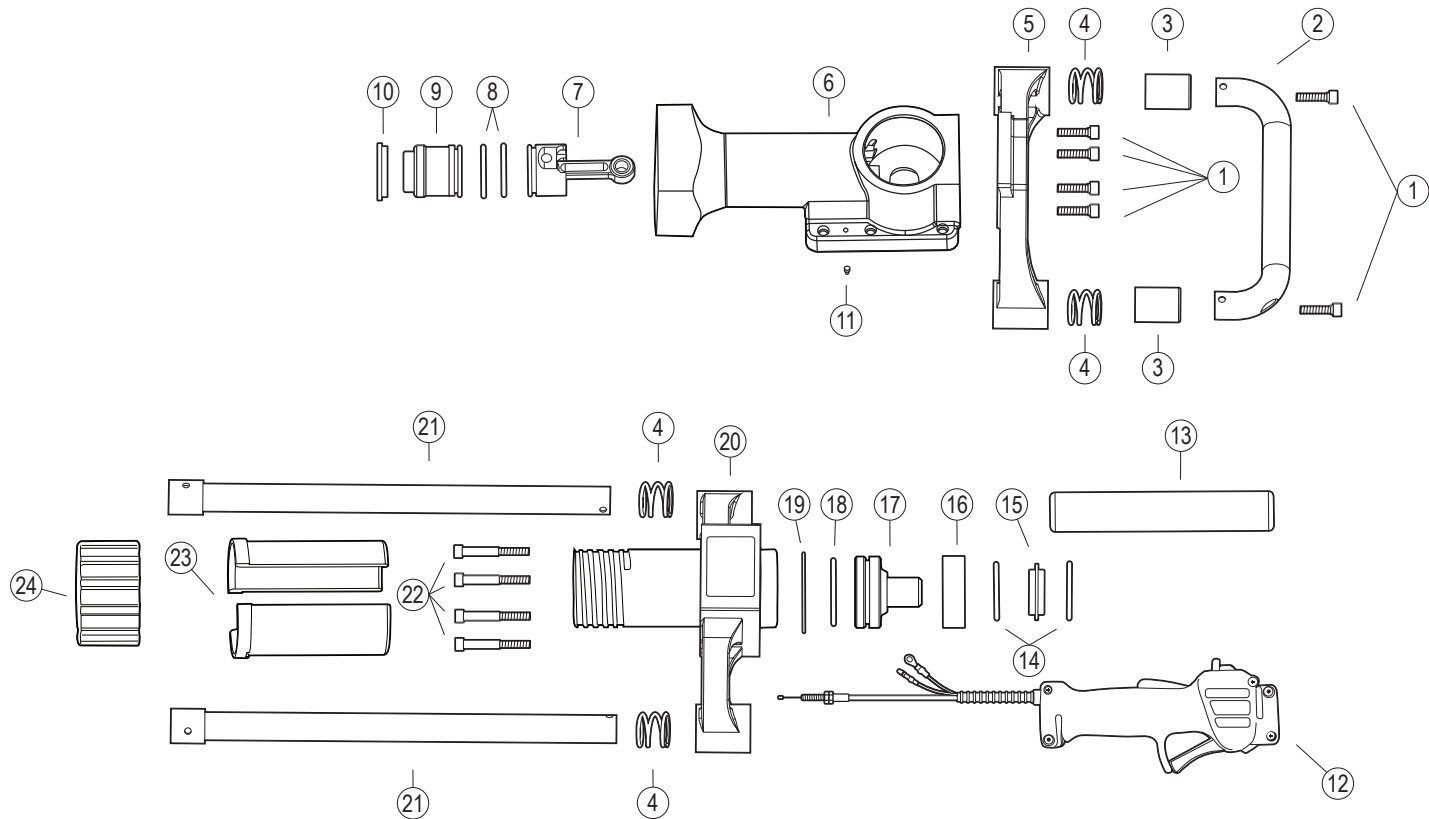

# RHINO® FENCE PRO™ PARTS

No.	P/N	Description
1	300715-4	Top Handle Bolt (Qty. of 4)
2	301222	Top Handle Assembly
3	301221-2	Handle Collar (Qty. of 2)
4	610010-4	Handle Anti-Vibration Spring (Qty. of 4)
5	300214	Top Handle Bracket
6	301015	Post Driver Body with Cylinder and Bearings
7	301075	Piston and Connecting Rod Assembly
8	301610-2	Piston O-ring Seal and Hammer O-ring Seal (Qty. of 2)
9	301080	Hammer
10	301110	Anvil O-ring Retainer
11	300712	Ground Bolt
12	300250	Throttle Control Assembly

No.	P/N	Description
13	300221	EPDM Handle Grip
14	301614-2	Large Retainer O-ring Seal (Qty. of 2)
15	301100	Large Retainer
16	301090	Anvil O-ring Cup
17	301160	Anvil
18	301616	Anvil O-ring
19	301618	Chuck Tube O-ring Seal
20	301034	Lower Body and Chuck Assembly*
21	301232	Handle (2 per driver)
22	300702-4	Lower Body Bolts Set
23	300902	Rhino® Chuck-Lok™ System 2" Adapter (1 per driver)
24	301920	Rhino® Chuck-Lok™ System Locking Nut

***\*For Serial # 9002752 and below use part no. 301033***

# RHINO® FENCE PRO™ PARTS

## NOTE

Disassembly of the Crankcase will break the tamper evident seal, thereby voiding the warranty on the driver

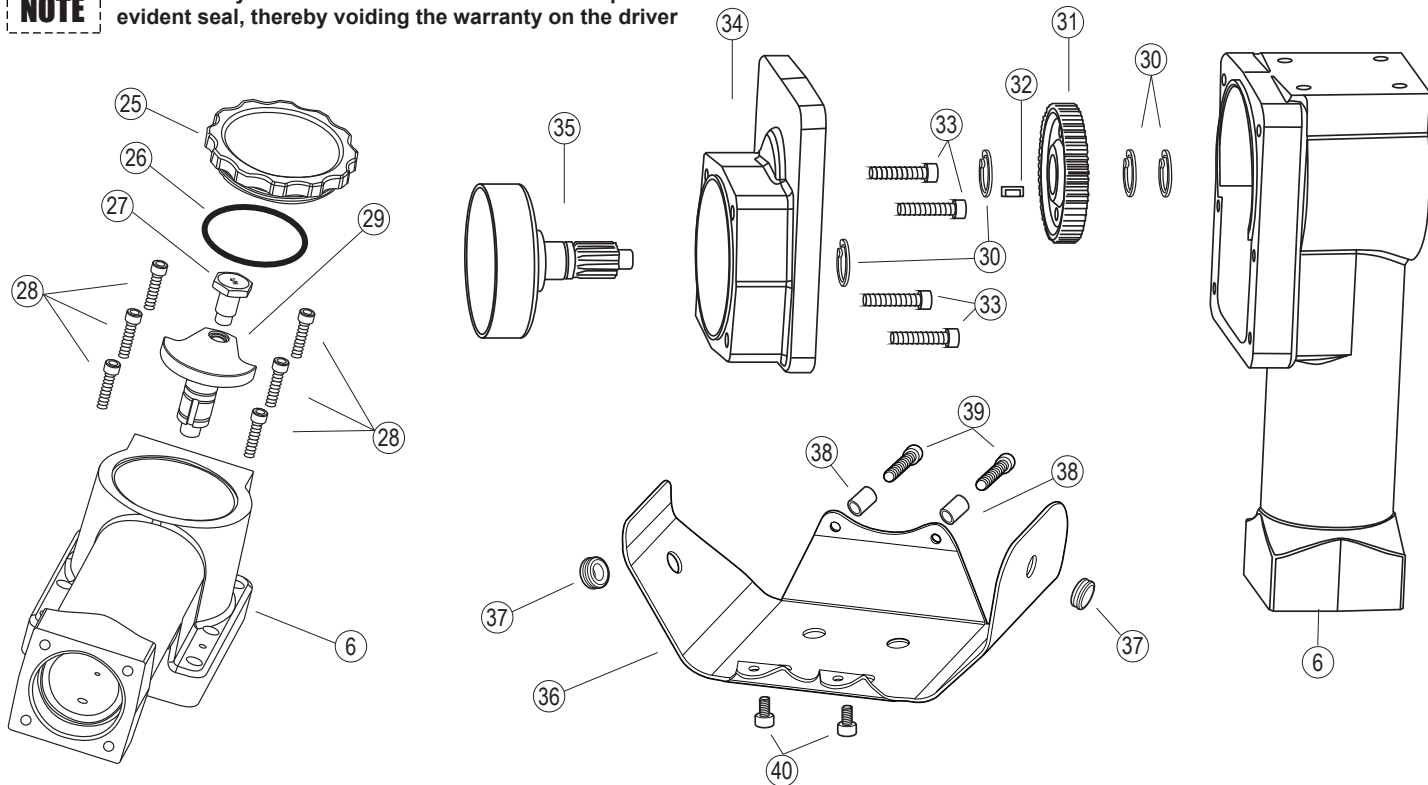

# RHINO® FENCE PRO™ PARTS

No.	P/N	Description
6	301015	Post Driver Body with Cylinder and Bearings
25	300132	Crankcase Cover
26	301617	Crankcase Cover O-ring Seal
27	300050	Crank Pin
28	300704-6	Crankcase Bolts (Qty. of 6)
29	300040	Crankshaft
30	300782-4	Retaining Ring for Crankshaft & Clutch Drum with Pinion Gear (Qty. of 4)
31	300200	Gear
32	300730	Key
33	300700-4	Clutch Housing Bolts (Qty. of 4)
34	300025	Clutch Housing with Bearings
35	300120	Clutch Drum with Pinion Gear
36	300180	Shroud
37	300181-2	Grommet (Qty. of 2)
38	300190-2	Shroud Spacer (Qty. of 2)
39	300706-2	Shroud Bolt (Qty. of 2)
40	300705-2	Lower Shroud Bolt (Qty. of 2)
	300240	Honda GX35 Engine
		Honda Engine Parts are Available from Your Local Honda Dealer
	301800	GPD-40 Fence Pro™ Owner's Manual
	300805	Safety Label and Tag Set

No.	P/N	Description
<b>Accessories</b>		
23	300902	Rhino® Chuck-Lok™ System 2" (50.8mm) Adapter
	300895	Rhino® Chuck-Lok™ System 1-3/4" (44.4mm) Adapter (optional)
	300900	Rhino® Chuck-Lok™ System 1" (25.4mm) Adapter (optional)
24	301920	Rhino® Chuck-Lok™ Locking Nut
	301233	Lower Handle Assembly (optional)
	301152	Fence Pro™ Short Euro Stake Chuck Tube
	301000	¼" Long Arm Hex Key
	300500	Rhino® Pro Series Lubricant
	301505	Service Kit for Fence Pro™ with O-Ring Cup
	301508	Service Kit for Fence Pro™ without O-Ring Cup
<b>Bolt Torque Specifications</b>		
1	300715-4	Top Handle Bolts (Qty. of 6) - 132.0 in/lbs (14.91 Nm)
22	300702-4	Lower Body Bolts (Qty. of 4)- 132.0 in/lbs (14.91 Nm) 251 lb/in (28.4 Nm) for black oxide bolts
27	300050	Crank Pin (Left Hand Threads)- 360.0 in/lbs (40.6 Nm)
28	300704-6	Crankcase Bolts (Qty. of 6) 75.0 in/lbs (8.5 Nm)
33	300700-4	Clutch Housing Bolts (Qty. of 4)- 95.0 in/lbs (10.73 Nm)
39	300706-2	Shroud Bolt (Qty. of 2)- 56.4 in/lbs (6.37 Nm)
40	300705-2	Lower Shroud Bolt (Qty. of 2) - 56.4 in/lbs (6.37 Nm)

## RHINO® LIMITED WARRANTY GAS/ PETROL POST DRIVER



**Warranty:** Rhino Tool Company, Inc. ("Rhino") warrants to the original purchaser, purchasing the Equipment in new condition, in original packaging from an authorized dealer that its Gasoline Powered Post Driver will be free from defects in workmanship and materials (the "Limited Warranty"). The Limited Warranty shall survive for the lifetime

of the product with respect to the Hammer and Anvil components and for twelve (12) months with regard to all other components, excluding the Honda GX35 engine for which Rhino provides no warranty and for which the warranty provided by American Honda Motor Co., Inc. shall be the sole warranty applicable thereto. This Limited Warranty is non-transferable.

For Warranty Claims contact your dealer or distributor. Proof of purchase date and serial number is required. In the event of a warranty repair, the post driver should be returned to a Registered and Warranty Authorized Rhino Servicing Dealer. Rhino's obligation under this Limited Warranty is expressly limited to the repair or replacement, at Rhino's election, of such defective Gasoline Powered Post Driver, which is proved to be defective upon inspection by a Rhino-certified/authorized technician.

This Limited Warranty does not extend to a Gasoline Powered Post Driver which has been subject to misuse, neglect, or accident, nor does it extend to any Gasoline Powered Post Driver which has been repaired, altered, or serviced by unauthorized persons. This Limited Warranty does not cover any damage or adjustments required to any Gasoline Powered Post Driver if such damage or adjustment is caused by the use of supplies, parts, or attachments not sold or approved by Rhino

**EXCEPT AS OTHERWISE PROVIDED HEREIN, RHINO DISCLAIMS ALL OTHER WARRANTIES, EXPRESS OR IMPLIED, INCLUDING, BUT NOT LIMITED TO THE IMPLIED WARRANTIES OF MERCHANTABILITY AND FITNESS FOR A PARTICULAR PURPOSE. UNDER NO CIRCUMSTANCES SHALL RHINO BE LIABLE FOR ANY LOSS OF BUSINESS, REVENUES, OR PROFIT OR OTHER INDIRECT, INCIDENTAL, SPECIAL OR CONSEQUENTIAL DAMAGES OR LOSS ARISING OUT OF ANY DEFECTS IN OR PERFORMANCE OF THE GASOLINE POWERED POST DRIVER, HOWSOEVER CAUSED.**

***To register your product:***

Fill out and mail in registration card supplied with post driver

***Or online visit:***

<http://rhinotool.com/contact-support/warranty-information/>

Symptom	Explanation/Procedure
<b>Post lodged in the driver</b>	<p>In the event that a driven post flares and becomes lodged within the chuck, follow these steps:</p> <ol style="list-style-type: none"> <li>1. Turn engine off. Remove the four 5/16" lower body bolts and separate the lower body casting from the driver body.</li> <li>2. Slide the lower body casting down the post to expose the flared top of the post. With the proper cutting tool for the type of post, cut through the post below the flared portion.</li> <li>3. Once the flared portion is removed, slide the lower body casting off the post and reassemble it to the driver. Please follow bolt tightening procedure and use threadlocker.</li> </ol> <p><b>Recommendation: Do not use "thin-wall" or light gauge round post with the Fence Pro™. It is very likely to flare this type of post at full throttle.</b></p>
<b>Drives post slow or sluggish engine performance:</b>	Typically this is resulting from improper driver storage or over-filling the oil causing the oil to seep into the combustion chamber. Position the driver vertically, remove the dipstick to check oil level. (See page 6) If you need to remove some oil, dispose of it properly. If oil is at proper level, follow the procedure listed in "Pull-start is frozen or hard to pull."
<b>Pull-start is frozen or hard to pull:</b>	This typically results from oil seeping into the combustion chamber from improper driver storage or overfilling the oil reservoir of the engine. Remove spark plug and pull hand grip several times until it pulls freely. Replace the spark plug. Check the oil level in oil reservoir to ensure proper level (page 6). Follow starting procedure. It is not unusual, for blue smoke to be emitted from the engine, let the engine run until smoke clears.
<b>Proper Storage:</b>	Do not lay horizontally on the driver side or resting on the engine. If the unit cannot be stored securely in the upright position, place the chuck on a flat surface, leaning toward the engine side until it is supported by the shroud and chuck. Position the driver on an angle with the top handle at the topmost point.
<b>Other problems or technical questions</b>	Other problems or technical questions: Document your serial number and contact Rhino Tool Company. Phone: 309.853.5555 or Toll Free 866-707-1808, Fax:309.856.5905, Email: <a href="mailto:service@rhinotool.com">service@rhinotool.com</a> .



**A TRADITION OF QUALITY AND SERVICE SINCE 1975**

**[WWW.RHINOTOOL.COM](http://WWW.RHINOTOOL.COM)**

Form 301800.09.2017

**Rhino Tool Company, Inc. | P.O. Box 111 | Kewanee, IL 61443**